

Shear Force and Bending Moment Diagrams

- Shear force and bending moment diagrams depict the variation of shear force and bending moment along the beam.
- Beam sign conventions must be used for plotting the shear force and bending moment diagrams.
- Positive Shear or moment are plotted above the baseline; negative shear or moment are plotted below the baseline.

Example

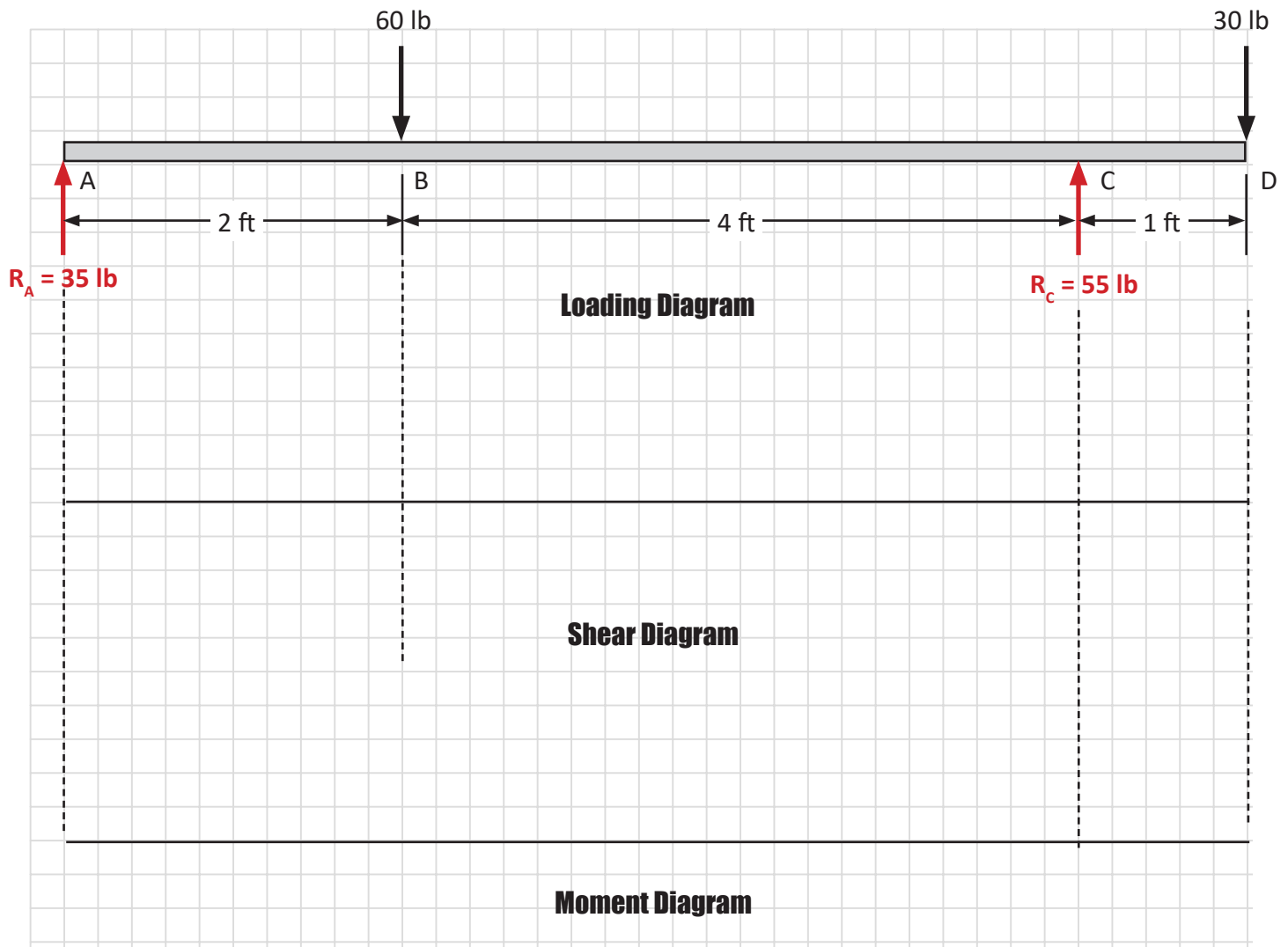

Example

Draw the shear force and bending moment diagrams for Ex 13-1.

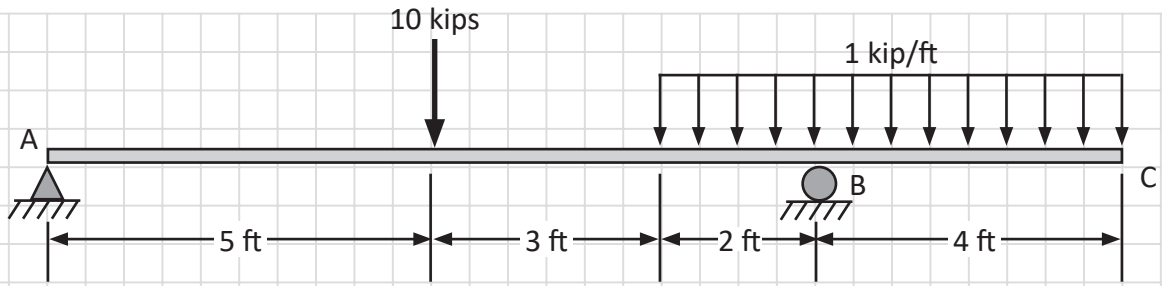

Solution.

13-7

Relationships Among Load, Shear, and Moment

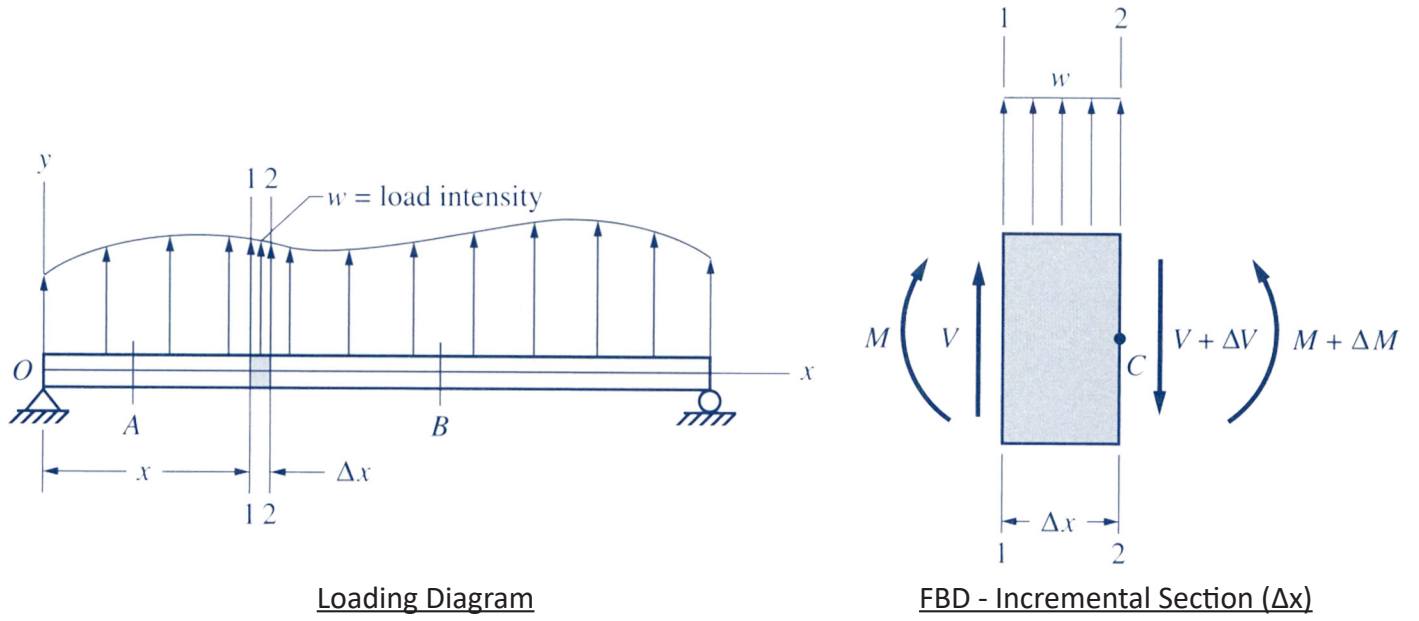

Relationship Between Load and Shear

Relationship between Shear and Moment

Sketching Shear and Moment Diagrams Using Their Relationships

The relationships established in the previous section may be used to facilitate the sketching of shear force and bending moment diagrams.

Loading Diagram. Show all the applied forces and reactions on the beam, including all the relevant dimensions along the beam. Never replace a distributed load by its equivalent concentrated force.

Shear Diagram. The following procedure may be followed for sketching the shear diagram:

1. For convenience and clarity, the shear diagram should be drawn directly below the loading diagram. A horizontal baseline for the shear diagram is drawn at a proper location below the loading diagram. Draw lines vertically downward from controlling sections, including the sections at the supports, sections at the concentrated forces, and the beginning and end of a distributed load.
2. Starting at the left end, compute the shear at the controlling sections using Equation 13-5. Note that at the section where a concentrated force is applied, the shear force diagram has an abrupt change of values equal to the concentrated load. An upward concentrated load causes an abrupt increase; a downward load causes an abrupt decrease.
3. Plot points on the shear diagram using the shear force of each controlling section as the ordinate. A positive value is plotted above the baseline; a negative value is plotted below the baseline.
4. Connect the adjacent points plotted, and keep in mind that the slope of the shear diagram is equal to the load intensity. The shear diagram is horizontal for the segment of the beam that is not loaded. At the segment of the beam where a downward uniform load is applied, the shear diagram is an inclined line with a downward slope. If the inclined line intersects the baseline, the shear force at the point is zero. Find the location of this point.

Moment Diagram. The following procedure may be followed for sketching the moment diagram:

1. The moment diagram is usually drawn directly under the shear diagram using the same horizontal scale. A horizontal baseline for the moment diagram is drawn at a proper location below the shear diagram. The controlling sections for the moment diagram include those used in sketching the shear diagram plus the section where the shear is zero or where the shear changes sign.
2. Calculate all the areas under the shear diagram between the adjacent controlling sections.
3. Note that the moments at the free end or the ends of a simple beam are always equal to zero. Starting at the left end, compute the moment at the controlling sections using Equation 13-7.

Example

Draw the shear force and bending moment diagrams for Ex 13-1.

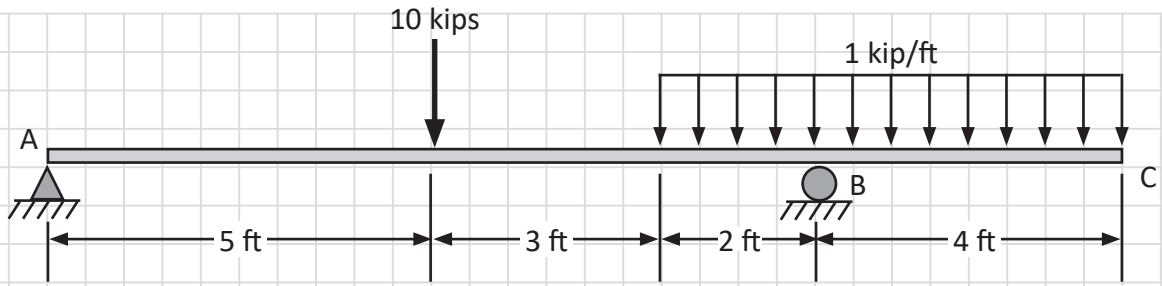

Solution.

Example

Draw the shear force and bending moment diagrams for the beam subjected to the loading shown.

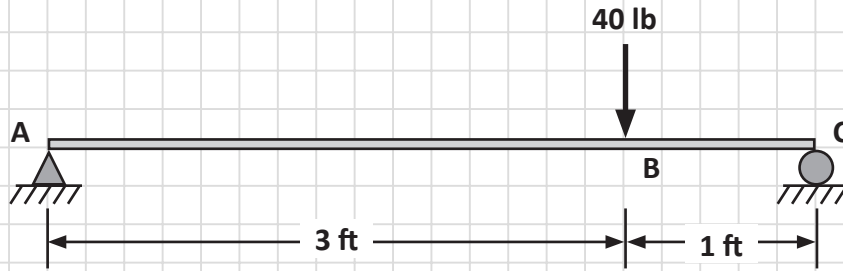

Solution.

Example

Draw the shear force and bending moment diagrams for the beam subjected to the loading shown.

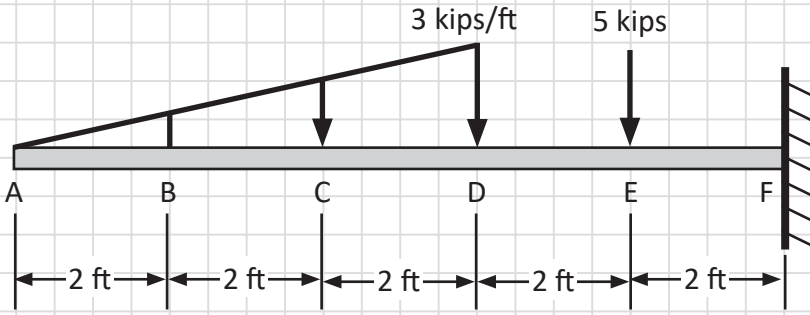

Solution.

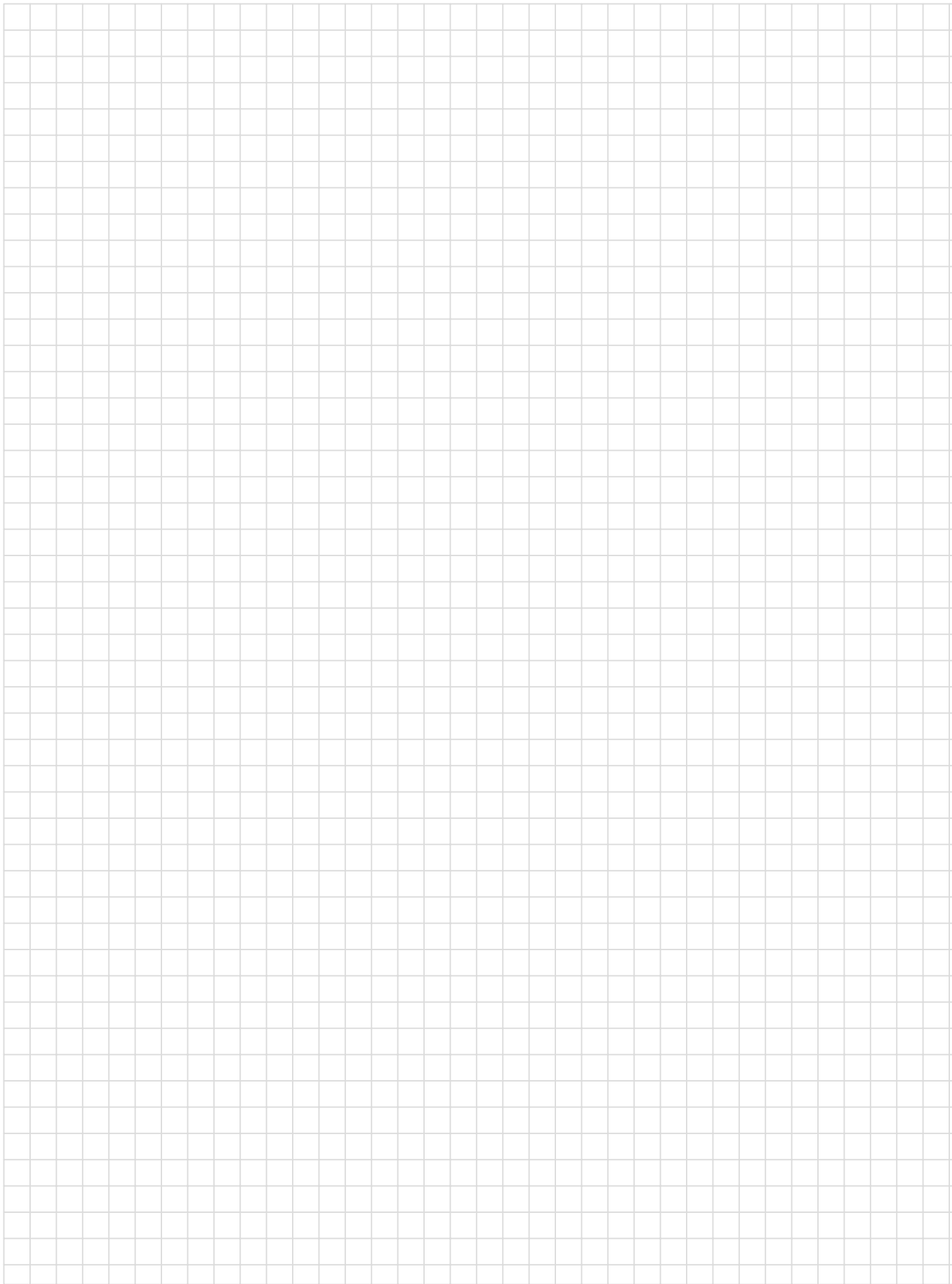

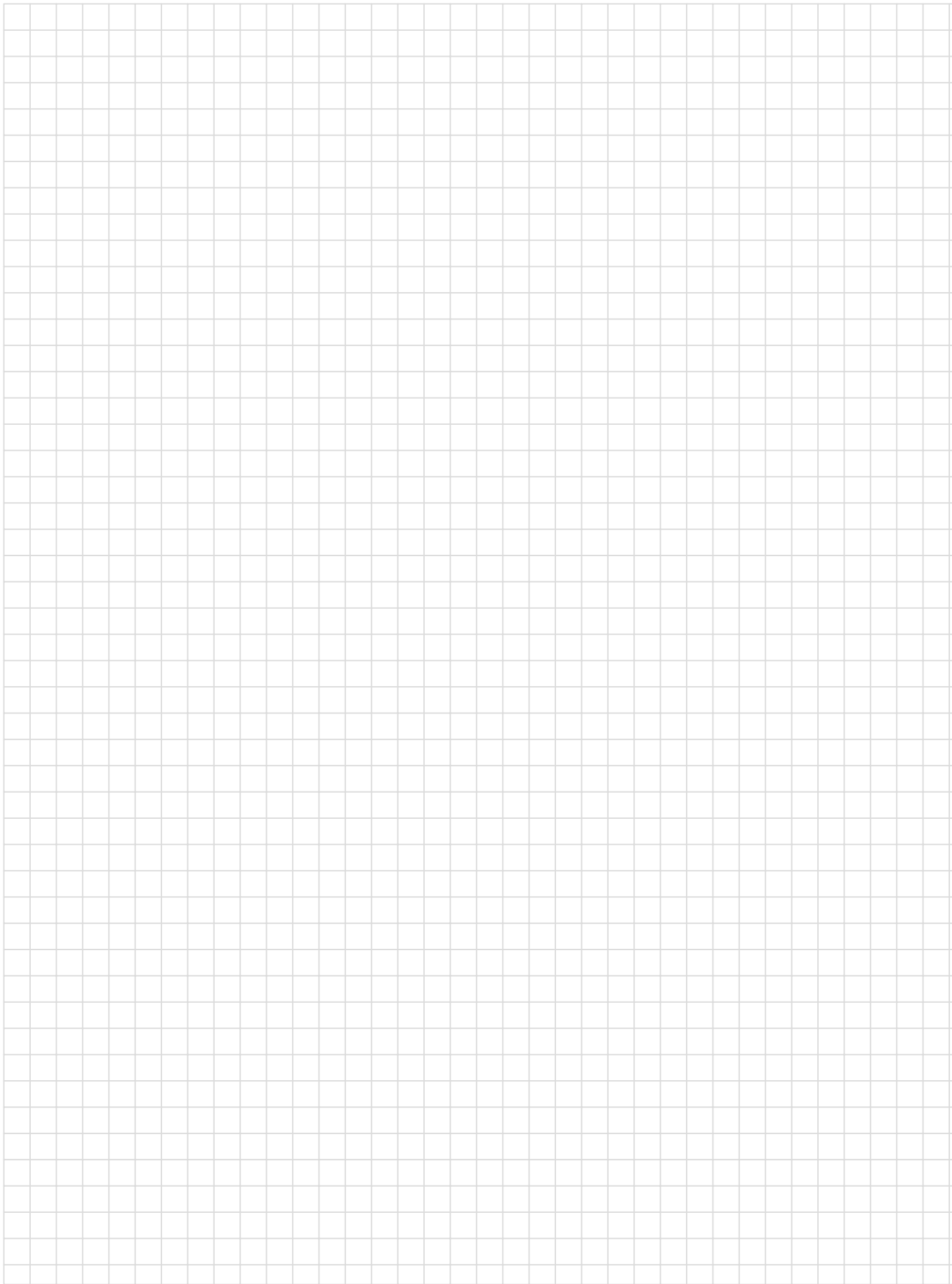

Example

Draw the shear force and bending moment diagrams for the beam subjected to the loading shown.

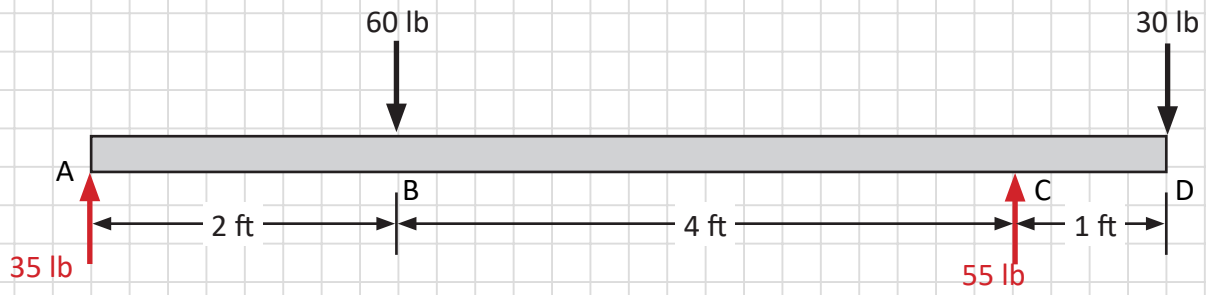

Solution.

Example

Determine the shear forces and bending moments at section A, B, C, D, E, and F for the beam subjected to the loading shown.

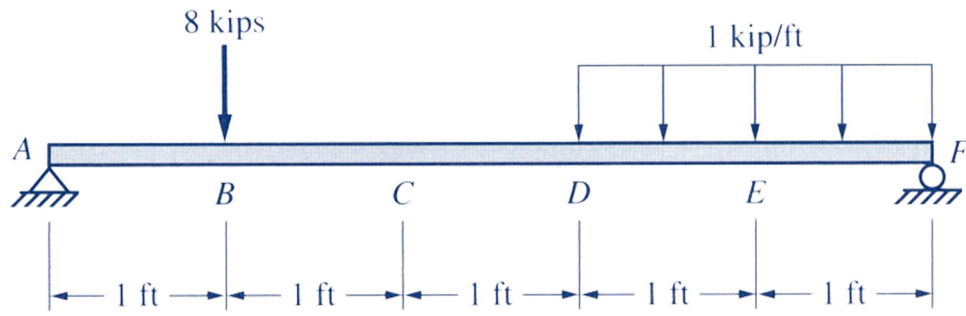

Solution.

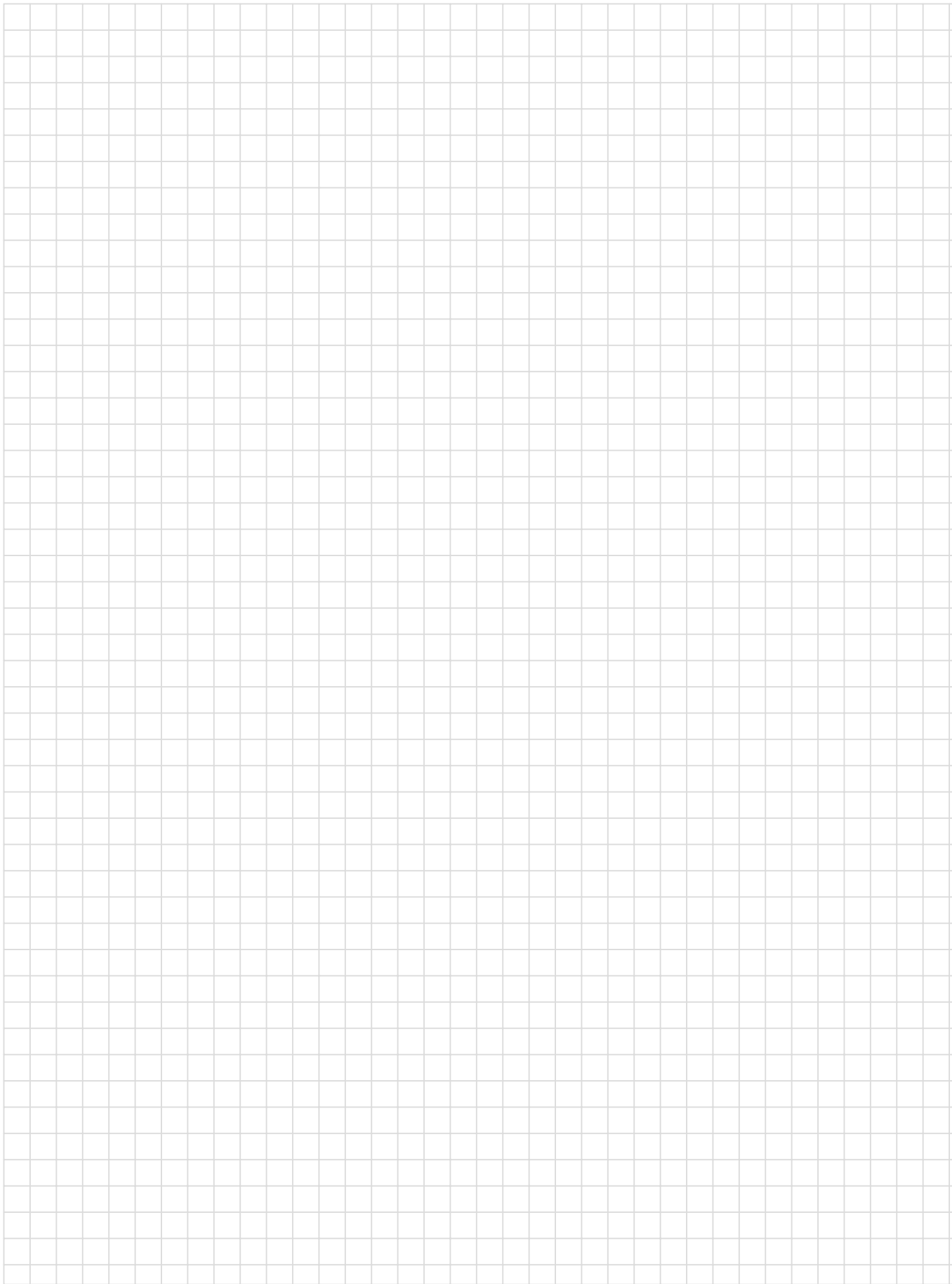

Example

Draw the shear force and bending moment diagrams for the beam subjected to the loading shown.

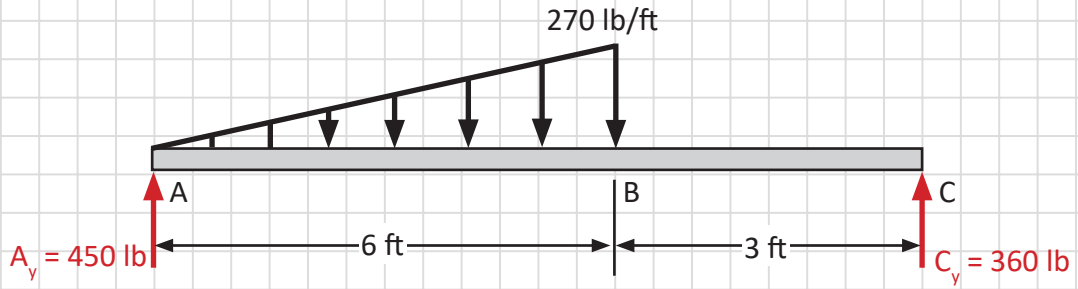

Solution.

Example

Draw the shear force and bending moment diagrams for the beam subjected to the loading shown.

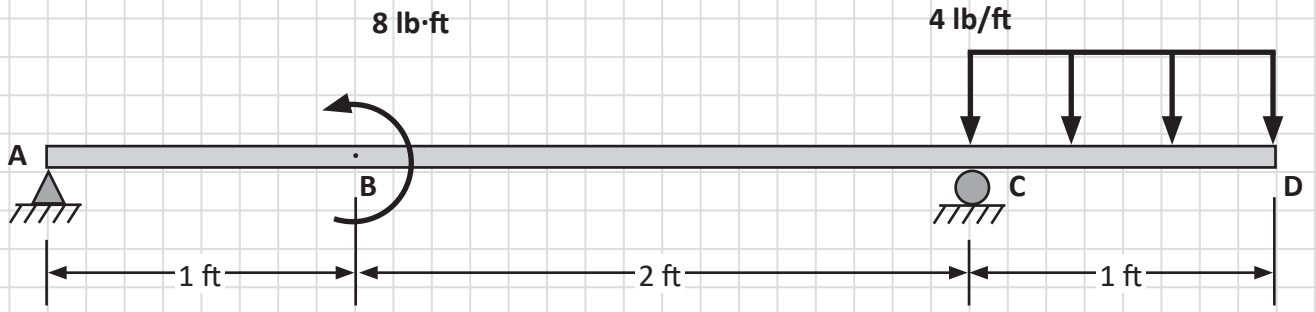

Solution.

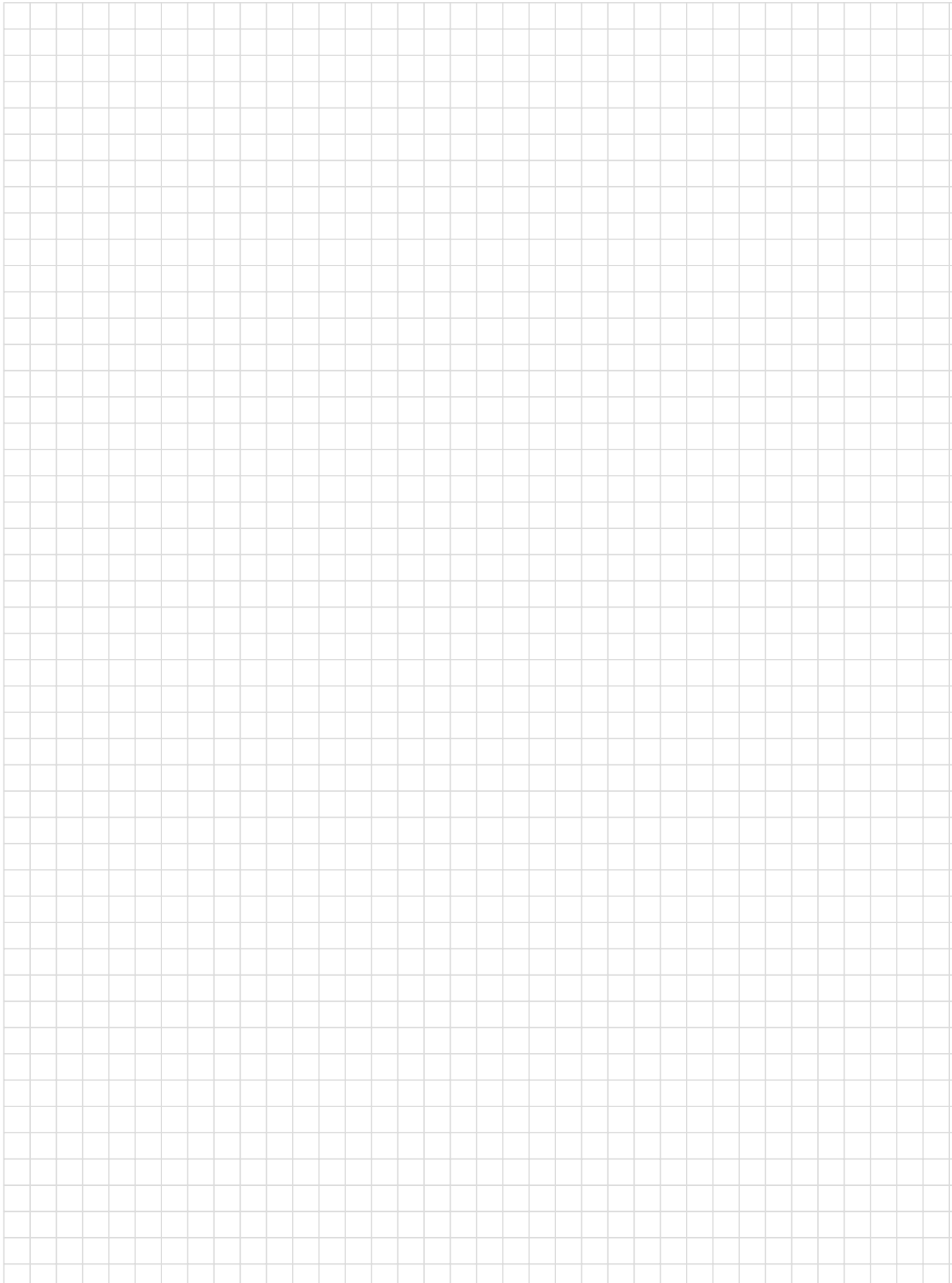

Example

Draw the shear force and bending moment diagrams for the beam subjected to the loading shown. Find the maximum bending moment.

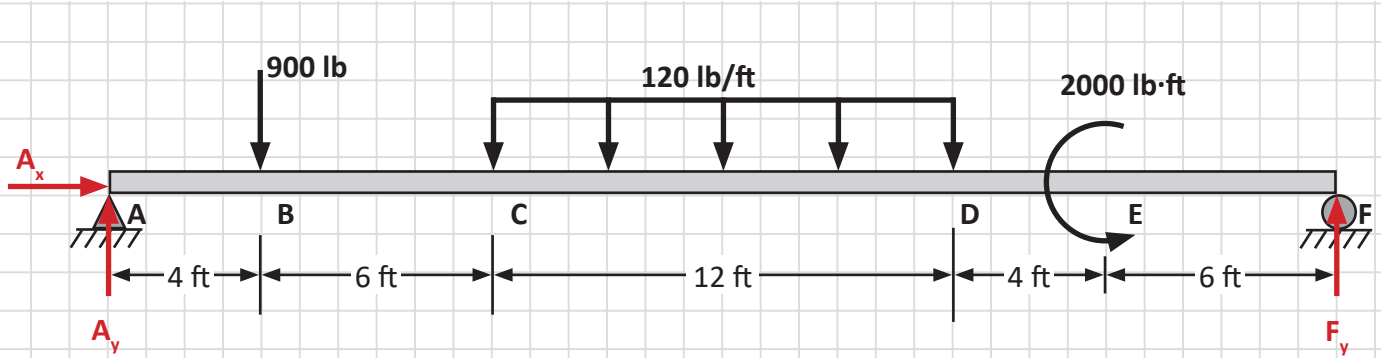

Solution.

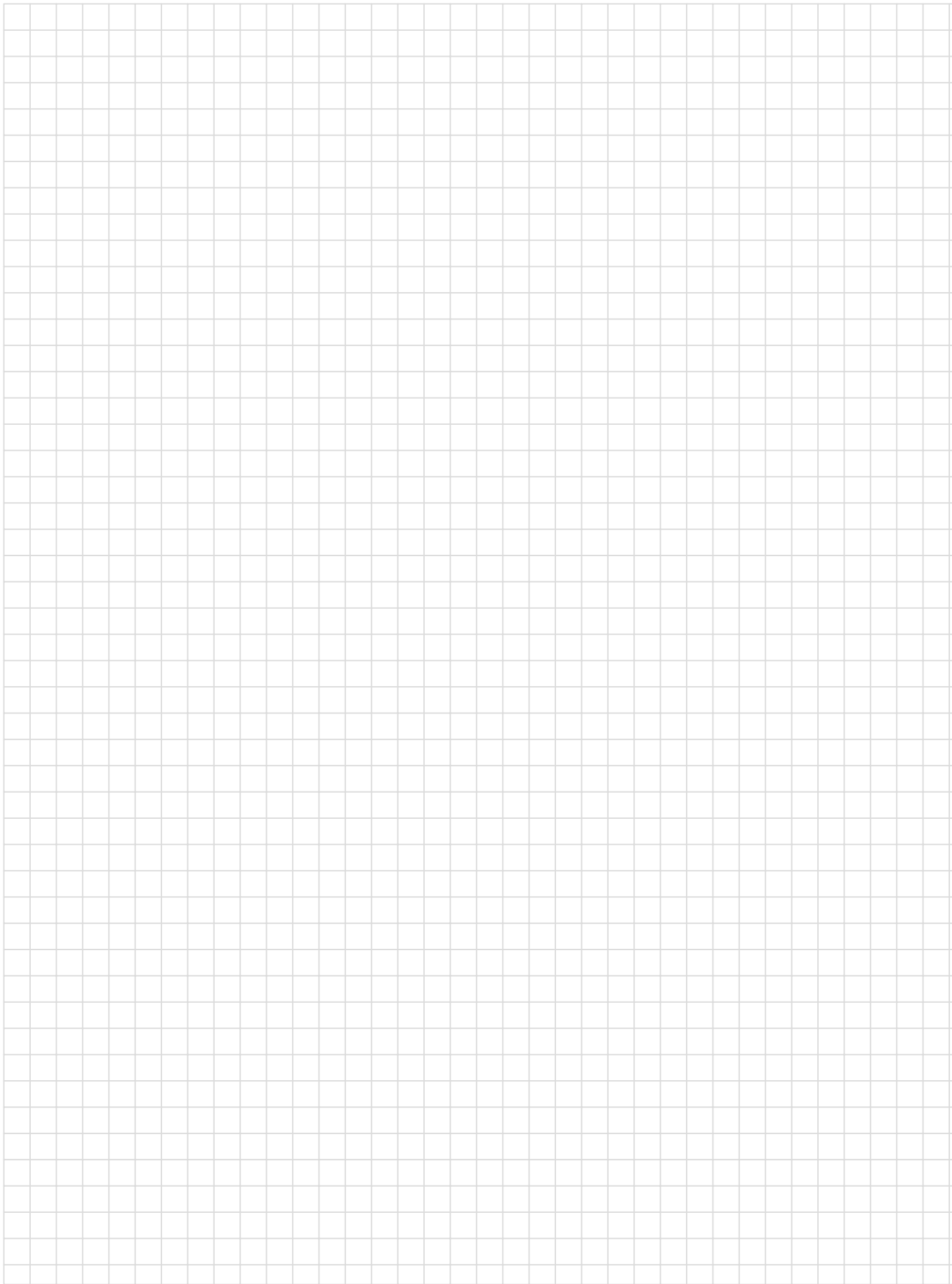

Example

Draw the shear force and bending moment diagrams for the beam subjected to the loading shown. Find the maximum shear force and the maximum bending moment.

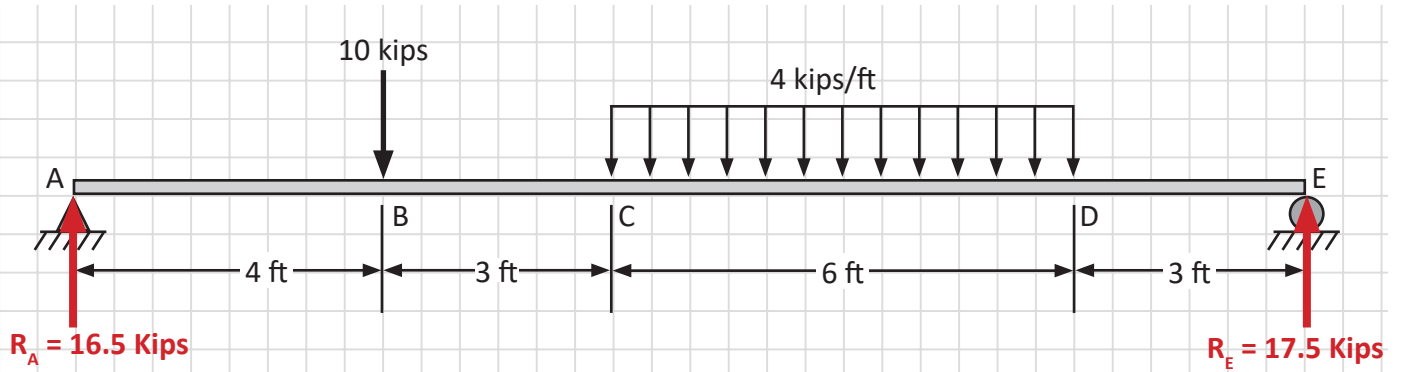

Solution.